



Growatt 750-S
Growatt 1000-S
Growatt 1500-S
Growatt 2000-S
Growatt 2500-S
Growatt 3000-S

Shenzhen Growatt New Energy Technology CO.,LTD
Building B, Jiayu Industrial Park, #28, GuangHui Road,
Shiyan Street, Baoan District, Shenzhen, P.R.China

T 0755-29515888
F 0755-27472131
E service@ginverter.com
W www.ginverter.com

Installation & Operation Manual

Contents

1 About Manual

- 1.1 Validity
- 1.2 Target Group
- 1.3 Additional information
- 1.4 Symbols in this document
- 1.5 Glossary

2 Safety

- 2.1 Intended Use
- 2.2 Qualification of skilled person
- 2.3 Safety instruction
- 2.4. Assembly Warnings
- 2.5. Electrical Connection Warnings
- 2.6. Operation Warnings

3 Product Description

- 3.1. Overview
- 3.2. Type label
- 3.3. Dimensions and Weight
- 3.4. Transport and Store
- 3.5. The advantage of Inverter

4 Unpacking

5 Installation

- 5.1. Safety instructions
- 5.2. Selecting mounting location
- 5.3. Mounting Inverter
- 5.4. Connect switch
- 5.5. Grounding
- 5.6. Connect grid type
- 5.7. Electrical connection

6 Commissioning

- 6.1. Parameters setting
- 6.2. Independent function option
- 6.3. LCD display
- 6.4. Communication
- 6.5. Commissioning the inverter
- 6.6. Monitoring tool instructions

7 Startup and Shutdown the Inverter

- 7.1. Start up the Inverter
- 7.2. Shutdown the Inverter

8 Operation Modes

- 8.1. Waiting mode
- 8.2. Normal mode
- 8.3. Fault mode
- 8.4. Shutdown mode

9 Maintenance and Cleaning

- 9.1. Checking heat dissipation
- 9.2. Checking the DC switch
- 9.3. Cleaning the Inverter

10 Trouble Shooting

- 10.1 Warnings(W)
- 10.2 Errors(E)

11 Decommissioning

- 11.1. Dismantling the Inverter
- 11.2. Packing the Inverter
- 11.3. Storing the Inverter
- 11.4. Disposing of the Inverter

12 Technical Data

- 12.1. Specification
- 12.2. DC connector info
- 12.3. Torque

13 PV System Installation

- 13.1. Single inverter
- 13.2. Multi inverters

14 Compliance Certificates

- 14.1. List
- 14.2. Download address

15 Contact

Manual Introduce and Copyright

Copyright © 2010 Shenzhen Growatt New Energy Technology Co., Ltd, All rights reserved.

No part of this document may be reproduced, stored in a retrieval system, or transmitted, in any form or by any means, electronic, mechanical, photographic, magnetic or otherwise, without the prior written permission of Shenzhen Growatt New Energy Technology Co., Ltd.

Shenzhen Growatt New Energy Technology Co., Ltd makes no representations, express or implied, with respect to this documentation or any of the equipment and/or software it may describe, including (with no limitation) any implied warranties of utility, merchantability, or fitness for any particular purpose. All such warranties are expressly disclaimed. Neither Shenzhen Growatt New Energy Technology Co., Ltd nor its distributors or dealers shall be liable for any indirect, incidental, or consequential damages under any circumstances.

(The exclusion of implied warranties may not apply in all cases under some statutes, and thus the above exclusion may not apply.)

Specifications are subject to change without notice. Every attempt has been made to make this document complete, accurate and up-to-date. Readers are cautioned, however, that Growatt reserves the right to make changes without notice and shall not be responsible for any damages, including indirect, incidental or consequential damages, caused by reliance on the material presented, including, but not limited to, omissions, typographical errors, arithmetical errors or listing errors in the content material.

All trademarks are recognized even if these are not marked separately. Missing designations do not mean that a product or brand is not a registered trademark.

SHENZHEN GROWATT NEW ENERGY TECHNOLOGY CO.,LTD
Building B, Jiayu Industrial Park, #28, Guanghui Road, Shiyan Street,
Baoan District, Shenzhen, P.R.China

1.1. Validity

This installation and user guide describes the assembly, installation, commissioning, communication, maintenance, operating and failure search of the following Growatt inverters:

- > Growatt 750-S
- > Growatt 1000-S
- > Growatt 1500-S
- > Growatt 2000-S
- > Growatt 2500-S
- > Growatt 3000-S

This manual does not cover any details concerning equipment connected to the Growatt (e.g. PV modules). Information concerning the connected equipment is available from the manufacturer of the equipment

1.2. Target group

This manual is for qualified personnel who have received training and have demonstrated skills and knowledge in the construction and operation of this device. Qualified Personnel are trained to deal with the dangers and hazards involved in installing electric devices.

1.3. Additional information





Find further information on special topics in the download area at www.ginverter.com

The manual and other documents must be stored in a convenient place and be available at all times. We assume no liability for any damage caused by failure to observe these instructions. For possible changes in this manual, SHENZHEN GROWATT NEW ENERGY TECHNOLOGY CO.,LTD accepts no responsibilities to inform the users.













1.4. Symbols in this document

1.4.1. Warnings in this document

A warning describes a hazard to equipment or personnel. It calls attention to a procedure or practice, which, if not correctly performed or adhered to, could result in damage to or destruction of part or all of the Growatt equipment and/or other equipment connected to the Growatt equipment or personal injury.

Symbol	description
	DANGER indicates a hazardous situation which, if not avoided, will result in death or serious injury.
	WARNING indicates a hazardous situation which, if not avoided, could result in death or serious injury.
	CAUTION indicates a hazardous situation which, if not avoided, could result in minor or moderate injury.
	NOTICE is used to address practices not related to personal injury.
	Information that you must read and know to ensure optimal operation of the system.

1.4.2. Markings on this product

Symbol	Explanation
	Electrical voltage!
	Risk of fire or explosion !
	Risk of burns
	Operation after 5 minutes
	Point of connection for grounding protection.
	Direct Current (DC)
	Alternating Current (AC)
	The inverter has no transformer.
	Read the manual.
	Bluetooth communication is enabled.
	CE mark. The inverter complies with the requirements of the applicable EC guidelines.
	The inverter must not be disposed of with the household waste.

1.5. Glossary

AC

Abbreviation for "Alternating Current"

DC

Abbreviation for "Direct Current"

Energy

Energy is measured in Wh (watt hours), kWh (kilowatt hours) or MWh (megawatt hours). The energy is the power calculated over time. If, for example, your inverter operates at a constant power of 1500W for half an hour and then at a constant power of 1000 W for another half an hour, it has fed 1250 Wh of energy into the power distribution grid within that hour.

Power

Power is measured in W (watts), kW (kilowatts) or MW (megawatts). Power is an instantaneous value. It displays the power your inverter is currently feeding into the power distribution grid.

Power rate

Power rate is the ratio of current power feeding into the power distribution grid and the maximum power of the inverter that can feed into the power distribution

Power Factor

Power factor is the ratio of true power or watts to apparent power or volt amps. They are identical only when current and voltage are in phase than the power factor is 1.0. The power in an ac circuit is very seldom equal to the direct product of the volts and amperes. In order to find the power of a single phase ac circuit the product of volts and amperes must be multiplied by the power factor.

PV

Abbreviation for photovoltaic

wireless communication

The external wireless communication technology is a radio technology that allows the inverter and other communication products to communicate with each other. The external wireless communication does not require line of sight between the devices and it is selective purchasing.

2.1. Intended Use

The unit converts the DC current generated by the photovoltaic (PV) modules to grid-compliant alternating current and performs single-phase feed-in into the electricity grid. Growatt 750-3000-S series inverters are built according to all required safety rules. Nevertheless, improper use may cause lethal hazards for the operator or third parties, or may result in damage to the units and other property.

Principle of a PV plant with this Growatt XXXX single-phase inverter

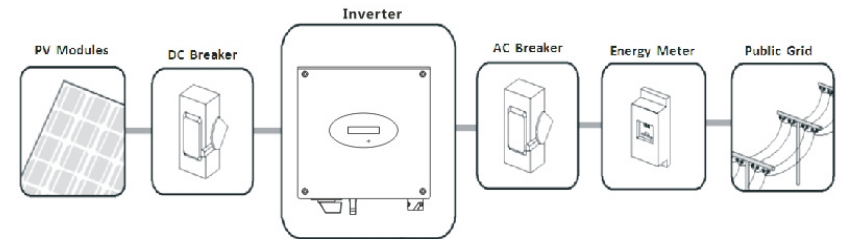

The inverter may only be operated with a permanent connection to the public power grid.

The inverter is not intended for mobile use. Any other or additional use is not considered the intended use. The manufacturer/supplier is not liable for damage caused by such unintended use. Damage caused by such unintended use is at the sole risk of the operator.

PV modules Capacitive Discharge Currents

PV modules with large capacities relative to earth, such as thin-film PV modules with cells on a metallic substrate, may only be used if their coupling capacity does not exceed 470nF. During feed-in operation, a leakage current flows from the cells to earth, the size of which depends on the manner in which the PV modules are installed (e.g. foil on metal roof) and on the weather (rain, snow). This "normal" leakage current may not exceed 50mA due to the fact that the inverter would otherwise automatically disconnect from the electricity grid as a protective measure.

2.2. Qualification of skilled person

This grid-tied inverter system operates only when properly connected to the AC –distribution network. Before connecting the inverter inverter to the power distribution grid, contact the local power distribution grid company. This connection must be made only by qualified technical personnel to connect, and only after receiving appropriate approvals, as required by the local authority having jurisdiction.

2.3. Safety instruction

The GROWATT Inverters are designed and tested according to international safety requirements; however, certain safety precautions must be observed when installing and operating this inverter. Read and follow all instructions, cautions and warnings in this installation manual. If questions arise, please contact Growatt's technical services at +86 (0)755 2951 5888.

2.4. Assembly Warnings

Symbol

description



- > Prior to installation, inspect the unit to ensure absence of any transport or handling damage, which could affect insulation integrity or safety clearances; failure to do so could result in safety hazards.
- > Assemble the inverter per the instructions in this manual. Use care when choosing installation location and adhere to specified cooling requirements.
- > Unauthorized removal of necessary protections, improper use, incorrect installation and operation may lead to serious safety and shock hazards and/or equipment damage.
- > In order to minimize the potential of a shock hazard due to hazardous voltage, cover the entire solar array with dark material prior to connecting the array to any equipment.



- > Grounding the PV modules : The Growatt inverter is a transformerless inverter. That is why it has no galvanic separation. Do not ground the DC circuits of the PV modules connected to the inverter. Only ground the mounting frame of the PV modules. If you connect grounded PV modules to the Growatt inverters, the error message "PV ISO Low".
- > Comply with the local requirements for grounding the PV modules and the PV generator. GROWATT recommends connecting the generator frame and other electrically conductive surfaces in a manner which ensures continuous conduction with ground these in order to have optimal protection of the system and personnel.

2.5. Electrical Connection Warnings

Symbol

description



- > The components in the inverter are live. Touching live components can result in serious injury or death.
 - Do not open the inverter except the wire box by qualified persons.
 - Electrical installation, repairs and conversions may only be carried out by electrically qualified persons.
 - Do not touch damaged inverters.
- > Danger to life due to high voltages in the inverter
 - There is residual voltage in the inverter. The inverter takes 20 minutes to discharge.
 - Wait 20 minutes before you open the wire box.
- > Persons with limited physical or mental abilities may only work with the Growatt inverter following proper instruction and under constant supervision. Children are forbidden to play with the Growatt inverter. Must keep the Growatt inverter away from children.



WARNING

- > Make all electrical connections (e.g. conductor termination, fuses, PE connection, etc.) in accordance with prevailing regulations. When working with the inverter powered on, adhere to all prevailing safety regulations to minimize risk of accidents.
- > Systems with inverters typically require additional control (e.g., switches, disconnects) or protective devices (e.g., fusing circuit breakers) depending upon the prevailing safety rules.



CAUTION

- > The Growatt Inverter converts DC Current from PV generator into AC current. The inverter is suitable for mounting indoors and outdoors.
- > You can use the AC current generated as follows:

House grid: Energy flows into the house grid. The consumers connected, for example, household devices or lighting, consume the energy. The energy left over is fed into the public grid. When the Growatt is not generated any energy, e.g., at night, the consumers which are connected are supplied by the public grid. The Growatt does not have its own energy meter. When energy is fed into the public grid, the energy meter spins backwards.

Public grid: Energy is fed directly into the public grid. The Growatt is connected to a separate energy meter. The energy produced is compensated at a rate depending on the electric power company.



CAUTION

- > All operations regarding transport, installation and start-up, including maintenance must be operated by qualified, trained personnel and in compliance with all prevailing codes and regulations.
- > Anytime the inverter has been disconnected from the power network, use extreme caution as some components can retain charge sufficient to create a shock hazard; to minimize occurrence of such conditions, comply with all corresponding safety symbols and markings present on the unit and in this manual.
- > In special cases, there may still be interference for the specified application area despite maintaining standardized emission limit values (e.g. when sensitive equipment is located at the setup location or when the setup location is near radio or television receivers). In this case, the operator is obliged to take proper action to rectify the situation.
- > Do not stay closer than 20 cm to the inverter for any length of time.

2.6. Operation Warnings

Symbol

description



WARNING

- > Ensure all covers and doors are closed and secure during operation.
- > Although designed to meet all safety requirements, some parts and surfaces of Inverter are still hot during operation. To reduce the risk of injury, do not touch the heat sink at the back of the PV-Inverter or nearby surfaces while Inverter is operating.
- > Incorrect sizing of the PV plant may result in voltages being present which could destroy the inverter. The inverter display will read the error message "PV Voltage High!"
 - Turn the rotary switch of the DC Disconnect to the Off position immediately.
 - Contact installer.

3 Product Description

The Growatt inverters are grid-tied inverters which convert DC current generated by PV modules into AC current and feed it into the public grid.

3.1. Overview

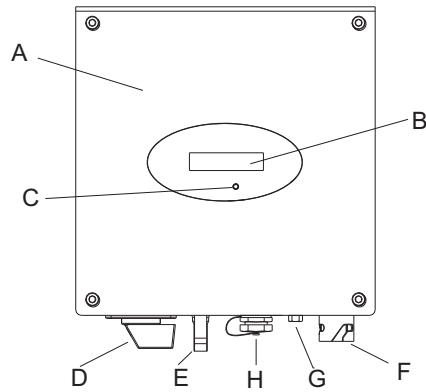

Position	Description
A	The front enclosure lid
B	LCD
C	State LED
D	DC switch
E	PV input terminals
F	AC Output
G	Waterproof breathable valve
H	RJ 45 Port

Symbol on the inverter

Symbol	Description	Explanation
	Tap symbol	Setting the display operation by tapping the LCD

	Inverter status symbol	Indicates inverter operation status
--	------------------------	-------------------------------------

3.2. Type label

The type labels provide a unique identification of the inverter (The type of product, Device-specific characteristics, Certificates and approvals). The type labels are on the left-hand side of the enclosure.

GROWATT PV Grid Inverter	
Model Name	xxxxxx
U_{DC max}	xxxV
I_{DC max}	xxxA
U_{DC range}	xxxV~xxxV
V_{AC norm}	xxxV
f_{AC norm}	xxxHz
P_{AC norm}	xxxxW
I_{AC norm}	xxxA
PF	xxxx
Protection Degree	xxxx
Operation Ambient Temperature	xxx°C~ xxx°C
IEC62109 G83 VDE0126-1-1	

	As the grid standards of many countries are in the process of improving or upgrading, please refer to the label on the machine for reference of the newest certificate.
--	---

More details about the type label as the chart below:

Model Name	Growatt 750-S	Growatt 1000-S	Growatt 1500-S
Max input DC voltage	450V	450V	450V
Max input DC current	10A	10A	11A
PV voltage range	50V-450V	70V-450V	70V-450V
AC nominal voltage	230V	230V	230V
AC grid frequency	50Hz/60Hz	50Hz/60Hz	50Hz/60Hz
Nominal AC output power	750W	1600W	2000W
AC normal output current	3.3A	6.9A	8.7A
Power factor	0.8leading-0.8lagging		
Environmental Protection Rating	Ip65	Ip65	Ip65
OperationAmbient temperature	-25...+60℃	-25...+60℃	-25...+60℃
Model Name	Growatt 2000-S	Growatt 2500-S	Growatt 3000-S
Max input DC voltage	450V	500V	550V
Max input DC current	11A	12A	13A
PV voltage range	50V-450V	70V-500V	70V-550V
AC nominal voltage	230V	230V	230V
AC grid frequency	50Hz/60Hz	50Hz/60Hz	50Hz/60Hz
Nominal AC output power	2000W	2500W	3000W
AC normal output current	8.7A	10.9A	13A
Power factor	0.8leading-0.8lagging		
Environmental Protection Rating	Ip65	Ip65	Ip65
OperationAmbient temperature	-25...+60℃	-25...+60℃	-25...+60℃

3.3. Dimensions and Weight

Types	Height (H)	Width (W)	Depth (D)	Weight
Growatt 750-S	299 mm	271 mm	141 mm	6.4 kg
Growatt 1000-S	299 mm	271 mm	141 mm	6.4 kg
Growatt 1500-S	299 mm	271 mm	141 mm	6.4 kg
Growatt 2000-S	299 mm	271 mm	141 mm	6.4 kg
Growatt 2500-S	359 mm	271 mm	141 mm	9.1 kg
Growatt 3000-S	359 mm	271 mm	141 mm	9.1 kg

3.4. Transport and Store

3.4.1. Transportation

The inverter is thoroughly tested and inspected strictly before delivery. Our inverters leave our factory in proper electrical and mechanical condition. Special packaging ensures safe and careful transportation. However, transport damage may still occur. The shipping company is responsible in such cases. Thoroughly inspect the inverter upon delivery. Immediately notify the responsible shipping company if you discover any damage to the packaging which indicates that the inverter may have been damaged or if you discover any visible damage to the inverter. We will be glad to assist you, if required. When transporting the inverter, the original or equivalent packaging should be used, and the maximum layers for original carton is seven as this ensures safe transport.

3.4.2. Storage of Inverter

If you want to storage the inverter in your warehouse, you should choose an appropriate location to store the inverter.

- The unit must be stored in original package and desiccant must be left in the package.
- The storage temperature should be always between -25℃ and +60℃. And the storage relative humidity can achieve to 100%.
- If there are a batch of inverters needs to be stored, the maximum layers for original carton as follow.
The maximum layers is 11 for Growatt 750-S-3000-S
- After long term storage, local installer or service department of GROWATT should perform a comprehensive test before installation.

3.5. The advantage of Inverter

- Maximum efficiency of 97.6%.
- Wide input voltage range from 50-550Vdc.
- Integrated DC switch.
- Sound control.
- Multi communication pattern.
- Easy installation.

Thoroughly inspect the packaging upon received. If any damage to the carton is visible, or if you find that the inverter unit is damaged after unpacking, please notify the shipping company and SHENZHEN GROWATT NEW ENERGY TECHNOLOGY CO.,LTD immediately.

Meanwhile please check the delivery for completeness and for visible external damages of the inverter. If there are anything damaged or missing, please contact your dealer. Don't dispose its original package. If you want to transport the inverter, it is better to store the inverter into the original package. After opening the package, please check the contents of the box. It should contain the following, Please check all of the accessories carefully in the carton. If anything missing, contact your dealer at once.

 Information	<p>Though the packaging box of Growatt inverter is durable, please treat the packing box gently and avoid dispose the packing box. In this package, there are inverter, cystosepiment and carton from inside to outside.</p> <p>For the accessories, there are two kinds of configuration, please refer to the inverter you receive.</p>
---	--

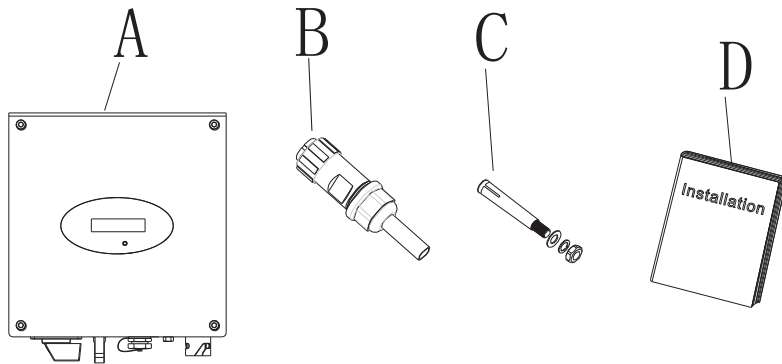

Item	Number	Description	Remarks
A	1	Growatt inverter	
B	1	AC connection plug	
C	2	Mounting screws	
D	1	Installation & Operation Manual	

5.1. Safety instructions

Danger to life due to fire or explosion



- > Despite careful construction, electrical devices can cause fires.
- > Do not install the inverter on easily flammable materials and where flammable materials are stored.

Risk of burns due to hot enclosure parts



- > Mount the inverter in such a way that it cannot be touched inadvertently.

- > All electrical installations shall be done in accordance with the local and national electrical codes. Do not remove the casing. Inverter contains no user serviceable parts. Refer servicing to qualified service personnel. All wiring and electrical installation should be conducted by a qualified service personnel.
- > Carefully remove the unit from its packaging and inspect for external damage. If you find any imperfections, please contact your local dealer.
- > Be sure that the inverters connect to the ground in order to protect property and personal safety.
- > The inverter must only be operated with PV generator. Do not connect any other source of energy to it.
- > Both AC and DC voltage sources are terminated inside the PV Inverter. Please disconnect these circuits before servicing.
- > This unit is designed to feed power to the public power grid (utility) only. Do not connect this unit to an AC source or generator. Connecting Inverter to external devices could result in serious damage to your equipment.
- > When a photovoltaic panel is exposed to light, it generates a DC voltage. When connected to this equipment, a photovoltaic panel will charge the DC link capacitors.
- > Energy stored in this equipment's DC link capacitors presents a risk of electric shock. Even after the unit is disconnected from the grid and photovoltaic panels, high voltages may still exist inside the PV-Inverter. Do not remove the casing until at least 5 minutes after disconnecting all power sources.
- > Although designed to meet all safety requirements, some parts and surfaces of Inverter are still hot during operation. To reduce the risk of injury, do not touch the heat sink at the back of the PV-Inverter or nearby surfaces while Inverter is operating.

5.2. Selecting mounting location

This is guidance for installer to choose a suitable installation location, to avoid potential damages to device and operators.

- The installation location must be suitable for the inverter's weight and dimensions for a long period time. (Refer to section 3.3)
- Do not install the inverter on structures constructed of flammable or thermolabile materials.
- Never install the inverter in environment of little or no air flow, nor dust environment. That may derate the efficiency of the cooling fan of the inverter.
- The Ingress Protection rate is IP65 which means the inverter can be installed outdoors and indoors.
- Do not expose the inverter to direct sunlight, in order to avoid the power and efficiency derating caused by excessive heating.
- The humidity of the installation location should be 0~100% without condensation.
- The ambient temperature should be below 40°C to ensure optimal operation.
- The installation location must be freely and safely to get at all times.
- Vertically installation and make sure the connection of inverter must be downwards. Never install horizontal and avoids forward and sideways tilt.(Refer to drawings below)

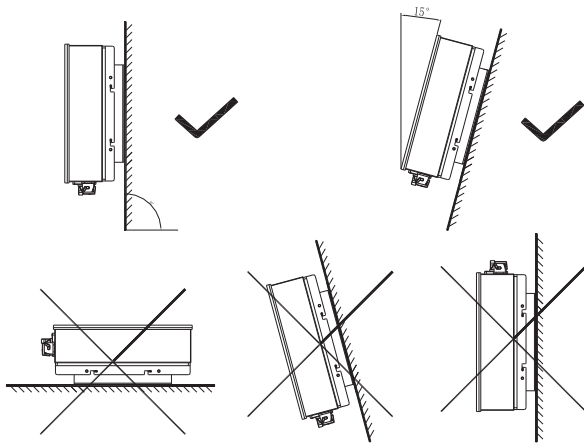

- Do not install the inverter near television antenna or any other antennas and antenna cables.
- Do not install the inverter in living area, the noise caused by the machine may affect on daily life.
- For security reasons, don't install the inverter in place where the children can reach.
- Don't put any things on the inverter. Do not cover the inverter.
- Inverter requires adequate cooling space. Providing better ventilation for the inverter to ensure the heat escape adequately.
- Do not expose the inverter to direct sunlight, as this can cause excessive heating and thus power reduction.
- Observe the minimum clearances to walls, other inverters or objects as shown in the diagram below in order to guarantee sufficient heat dissipation.

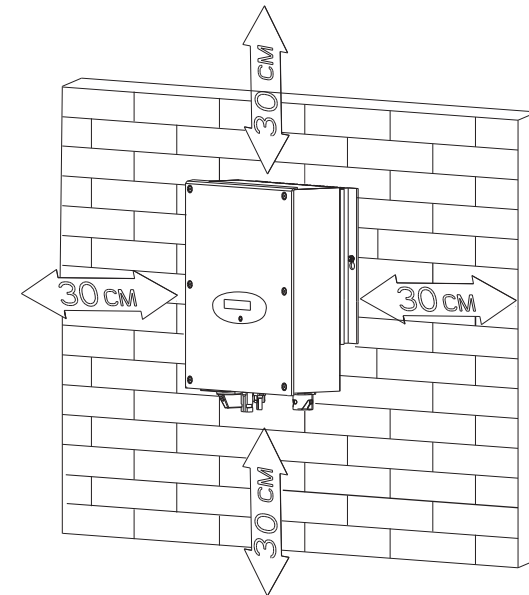

Ambient dimensions of one inverter

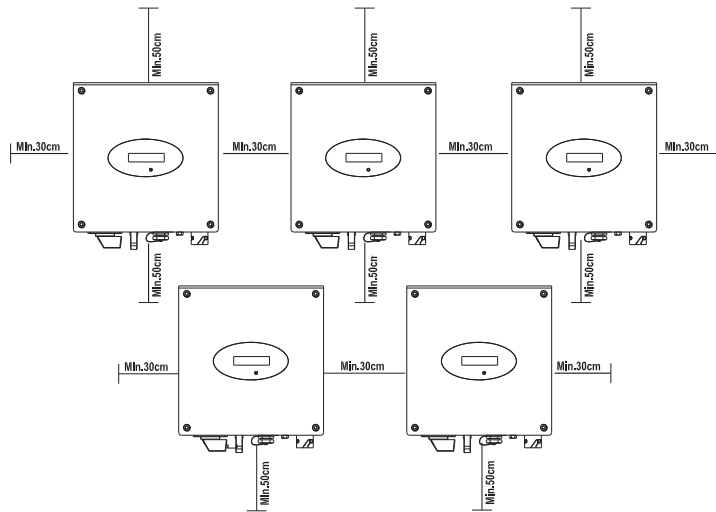

Ambient dimensions of series inverters

- There must be sufficient clearance between the individual inverters to ensure that the cooling air of the adjacent inverter is not taken in.
- If necessary, increase the clearance spaces and make sure there is enough fresh air supply to ensure sufficient cooling of the inverters.
- The inverter can't install to solarization, drench, firm location. We suggest that the inverters should be installed at the location with some cover or protection

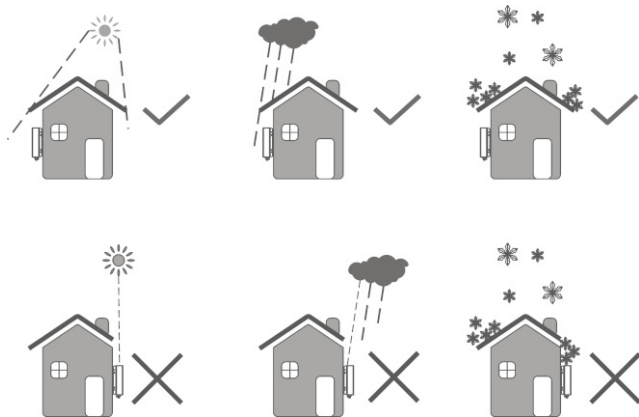

- Please make sure the inverter is installed at the right place. The inverter can't install close to trunk

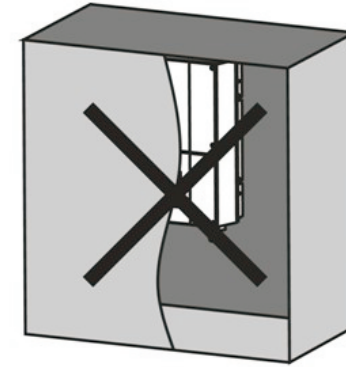

5.3. Mounting Inverter

5.3.1. Mounting bracket



In order to avoid electrical shock or other injury, inspect existing electronic or plumbing installations before drilling holes.

1. According to the following distance to drill two holes on the wall;
2. Install the explosion screw into the wall;

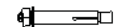
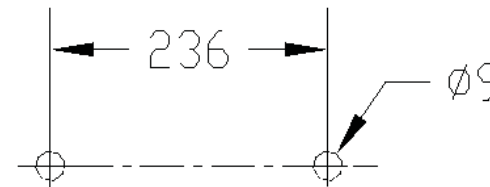

Falling equipment can cause serious or even fatal injury, never mount the inverter on the bracket unless you are sure that the mounting frame is really firmly mounted on the wall after carefully checking.

5.3.2. Mounting Inverter

- Referring to the following figure, make the inverter and explosion screw matching,
- Hang the inverter on the explosion screw

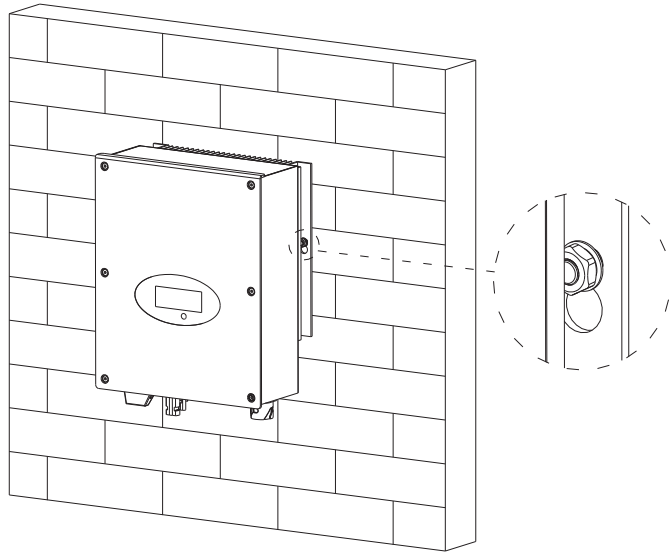

5.4. Connect switch

Separate the Growatt inverter securely from the grid and the PV generators using DC and AC Switch. You must provide an AC circuit breaker. If Growatt DC Switch is included in the delivery of the Growatt inverter, it must be used for operating the inverter.

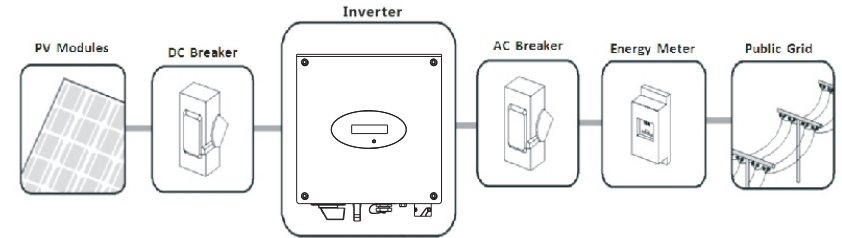

5.5. Grounding

The Growatt 750-S-3000-S series are transformerless inverters. That is why it has no galvanic separation. Do not ground the DC circuits of the PV modules connected to the inverter. Only ground the mounting frame of the PV modules. If you connect grounded modules to the inverter, the error message "PV ISO Low".

The inverter must be connected to the AC grounding conductor of the power distribution grid via the ground terminal (PE) .



Because of the transformerless design, the DC positive pole and DC negative pole of PV arrays are not permitted to be grounded.

5.6. Connect grid type

TN-C grid	suitable
TN-S grid	suitable
TN-C-S grid	suitable
TT grid	suitable

- Connecting the Second Protective Conductor
- If the installation requires, the earth terminal can be used to connect a second protective conductor or as equipotential bonding. This prevents touch current if the original protective conductor fails.
- Cable requirement:
Earthing cable cross-section: 3.332 mm² at maximum

5.7. Electrical connection

5.7.1. Safety



DANGER

Danger to life due to lethal voltages!
High voltages which may cause electric shocks are present in the conductive parts of the inverter. Prior to performing any work on the inverter, disconnect the inverter on the AC and DC sides.



WARNING

Danger of damage to electronic components due to electrostatic discharge.
Take appropriate ESD precautions when replacing and installing the inverter.

5.7.2. Connection to the grid(AC)



WARNING

You must install a separate single-phase circuit-breaker or other load disconnection unit for each inverter in order to ensure that the inverter can be safely disconnected under load.

NOTE: The inverter is equipped with integrated RCM(Residual current operated monitor)and RCD(Residual current and protective device) which are used for preventing from being electric shock. An external built RCD in fact is not necessary .
If the network operator stipulate an external built RCD,you must choose a residual-current protective device that triggers in the event of residual current more than 300mA.

Please connect AC cable obey the following procedures:

1.Switch off AC breaker and secure against being inadvertently switched back on.
About the AC breaker,please refer to the below form .

Types	Max current output	Suggested AC switch spec
Growatt 750-S	3.4A	400Vac/10A
Growatt 1000-S	4.7A	400Vac/10A
Growatt 1500-S	7.8A	400Vac/16A
Growatt 2000-S	9.5A	400Vac/16A
Growatt 2500-S	11.9A	400Vac/16A
Growatt 3000-S	14.3A	400Vac/16A

2. The grid connection is made using 3 conductors (L, N, and PE),We recommend the following requirements for Growatt 750-S/Growatt 1000-S/ Growatt 1500-S/Growatt 2000-S/Growatt 2500-S/Growatt 3000-S.

Model	_(mm)	Area(mm ²)	AWG no.	MAX.cable length(m)
Growatt 750-S	_2.05	3.332	12	124
Growatt 1000-S	_2.05	3.332	12	86
Growatt 1500-S	_2.05	3.332	12	50
Growatt 2000-S	_2.05	3.332	12	42
Growatt 2500-S	_2.05	3.332	12	34
Growatt 3000-S	_2.05	3.332	12	28

3.Remove the parts of the AC connection plug from the accessory bag.Guide the pressure screw, sealing ring, threaded sleeve over the AC cable

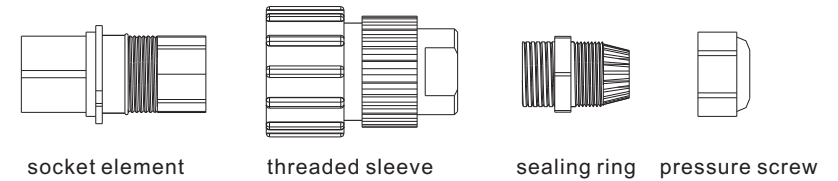

4.Insert the stripped and bared conductors L,N,PE into the screw terminals with sign L,N,PE on the socket element and tighten the screws firmly.

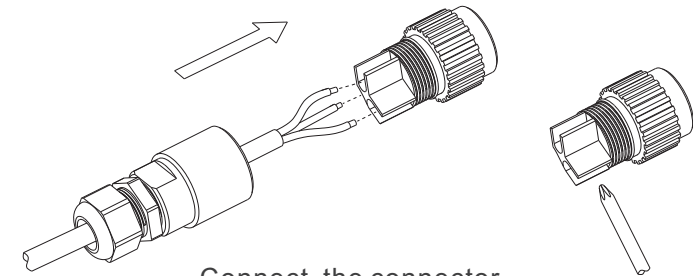

Connect the connector

5.Push the threaded sleeve into the socket element; screw the pressure screw tightly onto the threaded sleeve;

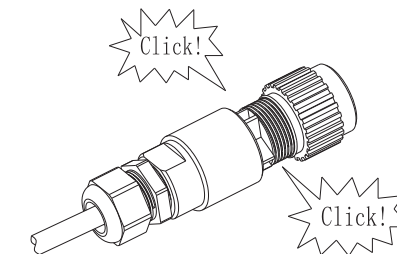

Close the connector

6.Finally, insert the AC connection plug into the AC connection receptacle on the inverter.

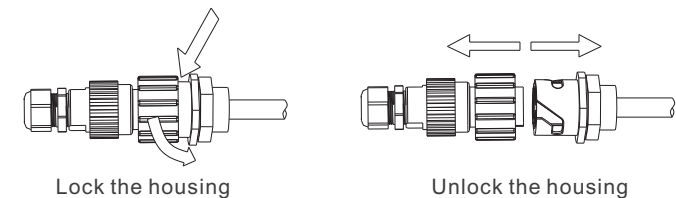

5.7.3. Connecting the PV array

5.7.3.1. Conditions for DC connection

The inverter has 1 independent string input.
The diagram drawing of DC side is shown as below, notice that the connectors are in paired (male and female connectors). The connectors for PV arrays and inverters are H4 connectors;

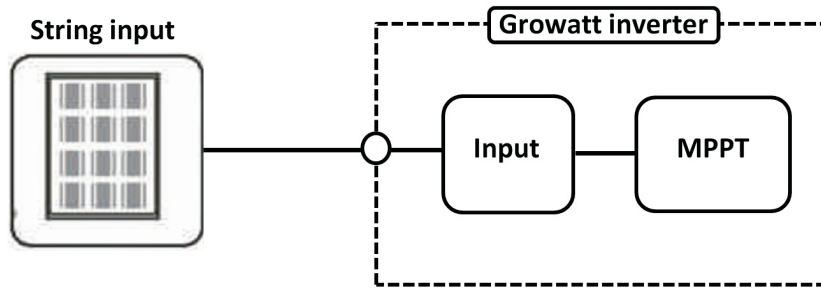

Requirements for the PV modules of the connected strings:

- > Same type
- > Same quantity of PV modules connected in series



CAUTION

If the inverter is not equipped with a DC switch but this is mandatory in the country of installation, install an external DC switch. The following limit values at the DC input of the inverter must not be exceeded:

Types	Max current input
Growatt 750-S	10A
Growatt 1000-S	10A
Growatt 1500-S	10A
Growatt 2000-S	11A
Growatt 2500-S	12A
Growatt 3000-S	13A

5.7.3.2. Connecting the PV array (DC)



Danger to life due to lethal voltages!
Before connecting the PV array, ensure that the DC switch and AC breaker are disconnect from the inverter. Never connect or disconnect the DC connectors under load.



Improper operation during the wiring process can cause fatal injury to operator or unrecoverable damage to the inverter. Only qualified personnel can perform the wiring work.



Risk of damage to the inverter.
If the voltage of the PV modules exceeds the maximum input voltage of the inverter, it can be destroyed by the overvoltage. This will void all warranty claims. Do not connect strings to the inverter that have an open-circuit voltage greater than the maximum input voltage of the inverter.

Check the connection cables of the PV modules for correct polarity and make sure that the maximum input voltage of the inverter is not exceeded. At an ambient temperature over 10 °C, the open circuit voltage of the PV modules should not exceed 90% of the maximum input voltage of the inverter. Otherwise, the maximum inverter input voltage may be exceeded at low ambient temperatures.

5.7.4 Inverter demand response modes (DRMs, only for Australia)

This series inverter has the function of demand response modes, moreover, We use RJ45 socket as inverter DRED connection.

5.7.4.1 RJ45 socket pin assignment

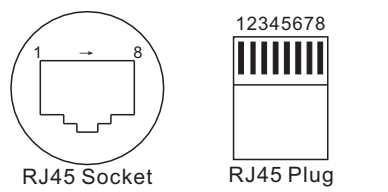
PIN	Assignment for inverterscapable of both charging and discharging	Pin Assignments Front View
1	DRM5	
2	DRM6	
3	DRM7	
4	DRM8	
5	RefGen	
6	COM/DRM0	
7	/	
8	/	

5.7.4.2 Method of asserting demand response modes

MODE	Rj45 socket Asserted by shorting pins		Requirement
DRM0	5	6	Operate the disconnection device
DRM5	1	5	Do not generate power
DRM6	2	5	Do not generate at more than 50% of rated power
DRM7	3	5	Do not generate at more than 75% of rated power AND Sink reactive power if capable
DRM8	4	5	Increase power generation (subject to constraints from other active DRMs)

6 Commissioning

6.1. Parameters setting

Users can use sound control function to change the display language and luminance of the display, enable auto-test function and choose utility model.

6.1.1. Language setting

Before entering the 'Set Language' interface, you need to enter a password as below:

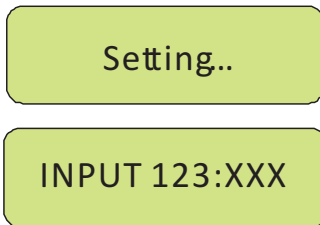

According to the LCD display, you need to input three numbers: 123. You should finish several steps as below:

1. When the LCD stays bright, single knock to 'Setting...', and then double knock to enter 'INPUT 123:xxx' interface.
2. Double knock to make the first number flash, single knock to change the number, and the first number you need to input is '1'. Double knock to enter the second number while the first number was '1'.
3. When the second number is flashing, single knock to change the number, and the second number you need to input is '2'. Double knock to enter the last number while the first number was '2'.
4. When LCD displays 'INPUT 123:123', triple knock to enter the setting interface.

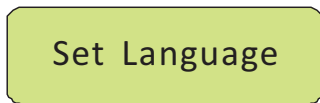

5. Single knock to "set language" → Double knock enter "language: English" → Single knock to select the language. After setting, you need to wait a few seconds until the display becomes dark, then the setting will be saved.

6.1.2. Set luminance of LCD display

1. If you want to set luminance of LCD display, repeat the steps as described in section 6.1.1.
2. When LCD displays 'INPUT 123:123', triple knock to enter the setting interface.



3. Single knock to "set LCD contrast" → Double knock to enter "LCD contrast 2" → Single knock to select the luminance. You also need to wait a few seconds after selecting. When the display becomes dark, the change is saved.

6.1.3. Set communication address

1. If you want to set communication address, repeat the steps as described in section 6.1.1.
2. When LCD displays 'INPUT 123:123', triple knock to enter the setting interface.

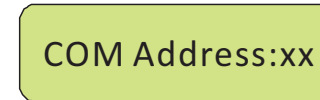

3. Single knock to "COM Address: xx" → Double knock change the address to set model → Single knock to set address. After selecting, you need to wait a few seconds until the display becomes dark, then the change is saved.

6.1.4. Set Queensland grid voltage range

1. If you want to set Queensland grid voltage range, repeat the steps as described in section 6.1.1.
2. When LCD displays 'INPUT 123:123', triple knock to enter the setting interface.



3. Single knock to item "Model: GTXXXXXX" → Double knock to enter "Normal Volt range" → Single knock to change it to "Qld Vmax 255V" → wait until the display become dark, then the inverter saved change.



This function is only for Ergon Energy area, Queensland, Australia.

6.1.5. Run auto test function(only for Italy)

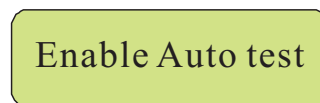

Single knock to make the display become bright → Single knock to "Enable Auto test" → Double knock to enter "Waiting to start" → Single knock to start auto test. and then waiting several minutes for the test result.

6.2. Independent function option

6.2.1. Country selecting

When the PV panels are connected and their output voltage is greater than 70Vdc but the AC grid is not yet connected, inverter will start up automatically. If it is the first time to power on the inverter after installation, you may need to select a specific country. Otherwise, the interface will stay at the 'Please Select' interface all the time. There are eleven options to select, as the list below.



If you have ordered the inverter with specific country settings, the parameters have been preset in factory and you don't need to operate this step any more.

This series inverter in Hungary market has not country settings.

Country/Regulation Name	options
VDE0126-1-1	//0
Germany	//1
UK_G83	//2
Italy	//3
France	//4
Denmark	//5
Belgium	//6
Spain	//7
Greece	//8
Turkey	//9



If the country you want to select is not in the above list, please directly select VDE0126-1-1.
Netherlands select VDE0126-1-1.

Please finish the country selecting according to the following steps

A The LCD will quickly switch to and stay at the 'Please select' interface after power on, as below:

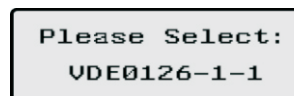

B Single knock on the LCD, countries will vary from one to another along the above list order. below acts as an example, and Germany is the second selection.

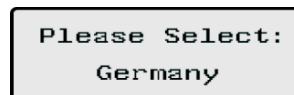

C When you need to select any of these countries, you can Double knock to enter the next interface. Here we select Italy as an example, as below:

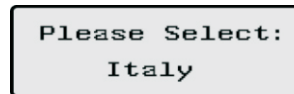

D When the country arrives at Italy, Double knock to enter the two options 'YES' and 'NO', and the cursor stays at 'NO' in default, as below:



E Single knock to select 'YES', as below:

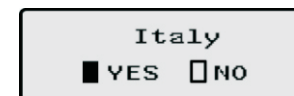

F Double knock to confirm your selection, LCD will display 'Select OK' with the country name in the below, as below:

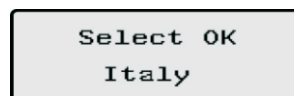



if you still single knock at the interface as E, the cursor will go to 'NO' again as D, then if you double knock, the display will switch to the interface as C.

G When the selection is successful, the inverter will reboot automatically



If you have selected and confirmed an unwanted country neglectful, please contact Growatt for specific software to clear and reset again.

6.2.2.Auto test

6.2.2.1.Spec of the CEI 0-21 SPI

SPI function : the integrated SPI consists of 4 voltage level protection and 2 frequency range protection. The protection logic is as follows:

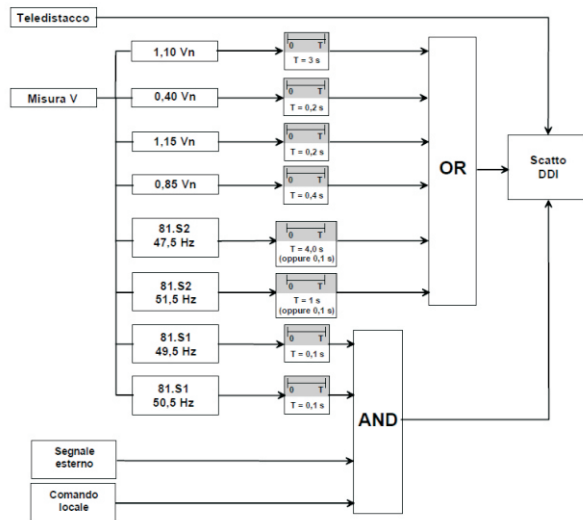

6.2.2.2.Autotest

- > Connect the Inverter and the PC by RS232;
- > Power on the inverter, check the inverter com address, and wait the inverter to connect to grid;
- > Open the PC software ShineBus, and select page "5 Auto Test"; set the PC com port(COM) and the inverter com address(Inv Add);
- > Click button "Test" to test the SPI function;

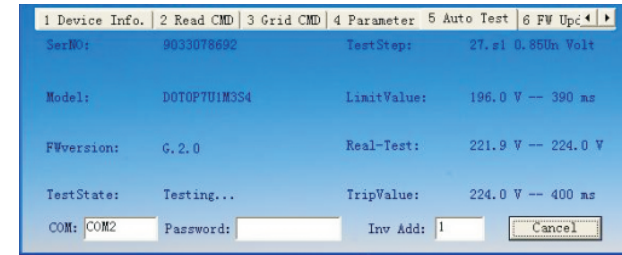

> Wait the test finish, there are 8 levels testing;

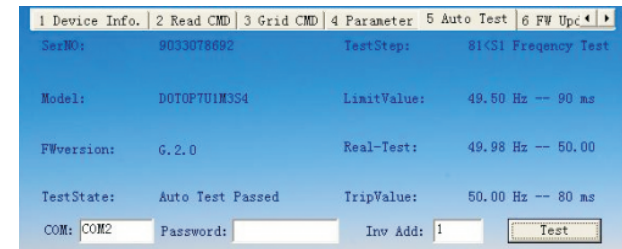

> The test result data is saved in the "Auto test report of xxxxxx .txt" under the Software install direction;

```

*****
SerialNO. : 1234567890
FW Version : G.2.0
Test Date : 31/07/2012
Start Time : 17:36:30

59.S2 1.15Un Volt
Limit Value : 263.0 V -- 180 ms
Trip Value : 229.0 V -- 180 ms
Step Result : PASS

27.s1 0.85Un Volt
Limit Value : 196.0 V -- 380 ms
Trip Value : 232.0 V -- 380 ms
Step Result : PASS

81>s2 Frequency
Limit Value : 51.50 Hz -- 60 ms
Trip Value : 49.95 Hz -- 60 ms
Step Result : PASS

81<S2 Frequency
Limit Value : 47.53 Hz -- 60 ms
Trip Value : 50.03 Hz -- 60 ms
Step Result : PASS

59.S1 1.10Un Volt
Limit Value : 252.0 V -- 2000 ms
Trip Value : 232.0 V -- 2005 ms
Step Result : PASS

27.s2 0.40Un Volt

```

➤ Test fail condition:

Condition	Reason	Suggestion
Test Stop	Communication lose or inverter occur other fault when testing	Check the communication or check the inverter state
Test fail	The trip value of the test result is not in the limit of the spec	Check the grid state, make sure the grid is stable, and retest

6.2.3. GFCI function

GFCI is short for Ground-Fault Circuit Interrupter which is used for preventing from being electric shock. The inverter is equipped with integrated RCD (Residual Current Protective Device) and RCM (Residual Current Operated Monitor). The current sensor will detect the volume of the leakage current and compare it with the pre-set value. If the leakage current is above the permitted range, the RCD will disconnect the inverter from the AC load.

6.2.4. PV isolation detection

The ISO function a protection mechanism. The inverter measures the resistances between both the positive pole and negative pole of PV panel and earth. Either of the measured value is lower than the limit, the PV inverter will not connect to grid, the output relay will stay open, and show 'PV isolation low'. The limited value is determined by the standards. The firmware setting of our PV inverters is 500Kohm. The simplified principle of the isolation resistance measurement is described as below:

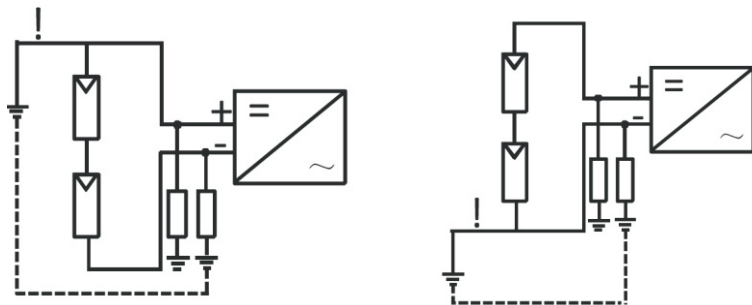

6.3. LCD display

In the lower center of inverter there is the LCD display. We can check inverter running status, etc. on the LCD screen. Items displayed can be changed by knock; you can also change some inverter parameters by knock.

6.3.1. General LCD display

Starting-up display sequence , once the PV power is sufficient , inverter displays information as shown in the flow chart as follow:

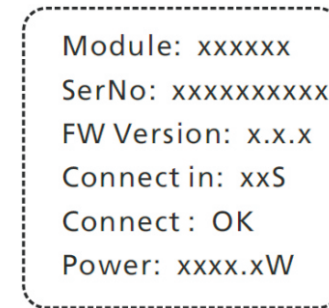

Power on LCD display

6.3.1.1. The first line of LCD

STATUS	DISPLAY CONTENT	REMARK
Waiting	Waiting	When the input voltage is between 70V and 80V during start up, inverter will display 'waiting'
	Standby	When the input voltage falls to 70V, inverter will display standby. The inverter will shut down when input voltage is lower than 60V.
Normal	Connect in xxS	System checking
	Reconnect in xxS	System checking
	Connect OK	Connecting to the grid
Fault	Power: xxxx.xW	Inverter output power in normal mode.
	Error: xxx	System fault
Auto Test	Auto Testing	Protecting function
Programming	Programming	Firmware update

i
Information

In fault mode, there can be different error messages displayed in the LCD due to different faults. Please refer to Chapter 10 for reference. The first line of LCD display can be changed by knock on the LCD screen. The second line automatically changes in the interval of 2 or 4 seconds as above Table.

6.3.1.2. The second line of LCD

CYCLE DISPLAY	DISPLAY TIME/S	REMARK
Power : 2013.4W model: P1U1M3S3	2	Model number of the inverter
Power : 2016.8W FW Version:H.1.0	2	Firmware version of the inverter
Power : 2012.8W SerNO: DK00000000	2	Serial number, which is also shown on
Power : 2009.6W Etoday: 7.1kWh	4	Energy generated today. For accurate energy to get the FIT payment, please refer to your meter
Power : 2017.0W Eall : 90KWH	4	Total generated energy since installation. For accurate energy to get the FIT payment, please refer to your meter
Power : 2015.0W PV : 250V B: 360V	4	PV voltage (PV) and Bus voltage (B)
Power : 2016.2W AC: 230V F: 50.0Hz	4	Grid voltage (AC) and frequency (F)
Power : 2021.8W Enale Auto Test	4	Enable auto test function
Power : 2019.5W COM Address: Move	4	Communication address of the inverter

Power : 2008.2W
Setting...

4

Setting status

6.3.2. LCD control

To save power, the LCD display's background light will turn off automatically in 10 seconds. Single knock will turn on the background light. The display on the inverter can be controlled by knocking the sound control panel in front of it.

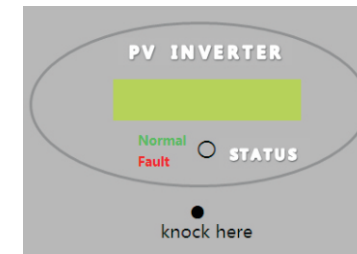

6.4. Communication

A detailed wiring diagram and installation description can be found in the communication module manual.

6.4.1. RS232 (standard)

RS 232 is used for single point communication. Use a RS 232 cable to connect from inverter's RS 232 port to computer's RS 232 port, or to connect to a RS232-to-USB converter, then connect to computer's USB port. And then run ShineNet to monitor the inverter.

6.4.2. WIFI (Optional)

WiFi module (It is available from Growatt.) can be used as an optional monitoring scheme. The ways to install the WIFI modules and to monitor your inverters refer to the WIFI module manual.

6.5. Commissioning the inverter

1. If the inverter connects with PV panel arrays and the input voltage is higher than 70Vdc, while the AC grid is not connected yet, LCD will display messages in order as below:
'Ser NO: xxx'->'xxxx'->'FW version'->'Waiting'->'No AC connection', the display repeats 'NO Utility' and LED will be red.

2. Turn on the AC breaker or close the fuse between inverter and grid, the system will operate normally.

3. Under normal operating conditions, the LCD displays 'Power: xxx.x W' at State info, this is the power fed into grid. LED turns green.

4. Finish commissioning.

6.6. Monitoring tool instructions

6.6.1. ShineNet

ShineNet is a monitoring software applied to monitor Growatt inverters via RS232 port or Bluetooth module. With the special designed functions and friendly compact UI, it can comprehensively meet users' requirements for system monitoring and bring unprecedented user experience.

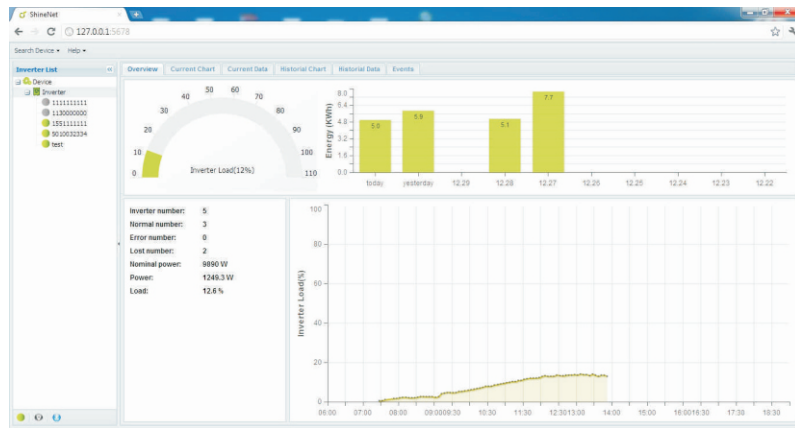

Features:

- Monitor and record current data and of inverters.
- Record historical data.
- Monitor and record event information of inverter
- Connect computer and inverter via RS232 and RS485 port (wire connection) or Bluetooth module (wireless connection).
- Remote access available for local area network.



Information

Users are able to monitor the inverter after the setting of software. Detailed information about setting and functions refer to the ShineNET Manual.

You can download the ShineNet YN2.0 from: <ftp://113.106.58.169>, the user name is ftpguest and Password is ftpguest.

ShineNet may be upgraded for better function or user experience, please refer to the actual software version.

6.6.2. ShineVision

ShineVision is a wireless monitoring device, which consists of a power monitor and a number of transmitters, and one shinevision can monitoring 1 to 6 inverters. The transmitters transmit the running data collected from photovoltaic inverters to the monitor and display the data onto the monitor screen, including data of generated energy, the gross generated energy and the generation income obtained from the above-mentioned data through some simple calculations, indoor temperature, date and time, as well as CO2 emissions.



Features:

- Monitor and transmitter communicate via wireless communication technology.
- External transmitter, with IP65 waterproof and dustproof.
- A monitor can simultaneously communicate with six transmitters.
- Communication distance between monitor and transmitter : 30 meter.
- Power supply option: built-in battery slot, an external DC power supply.
- Easy installation, and convenient to use it.



Information

The Monitor should be kept indoor. For detailed information, please refer to ShineVision Manual.

6.6.3. ShineWebBox

It is a cost-effective and compact monitoring device, specially designed for solar power plant. Using stable Linux operating system with high-speed CPU, it can smartly record your system features. ShineWebBox Provides local storage, easy wireless and TCP/IP configuration, and presents plant data over Internet.



Features:

- > A multi-functional and high-performance communication data logger; Keep user informed of the system's status at any time.
- > Massive storage with flexible parameters setting, system information management, error prompt and record.
- > Collects data and uploads information over the internet in near real-time to Growatt Shine Server platform.

7.1. Start up the Inverter

1. Connect the line circuit breaker from single phase.
2. Turn on the DC switch, and the inverter will start automatically when the input voltage is higher than 70V.
Note:For Growatt 750-S,the start voltage is 50V

7.2. Shutdown the Inverter

1. Disconnect the line circuit breaker from single phase and prevent it from being reactivated.
2. Turn off the dc switch.
3. Check the inverter operating status.
4. Waiting until LED, display have gone out, the inverter is shut down.

8 Operation Modes

8.1. Waiting mode

When the PV voltage is higher than 70V, Inverter will be powered up, and enters "waiting" mode. In this mode, inverter will check the system parameters. If the system is normal, and PV voltage is higher than 80Vdc, the inverter will attempt to connect to grid.

8.2. Normal mode

In this mode, the inverter works normally and LED turns green.

- > Whenever the DC voltage is higher than 80Vdc, inverter converts power to grid as generated by the PV panels;
- > Whenever the DC voltage is lower than 70Vdc, the inverter will work in standby state and attempt to connect the grid. In waiting state the inverter consumes just enough power generated by the PV panel to monitor the internal system status;



The inverter starts up automatically when the DC power from the PV panel is sufficient.

Information

8.3. Fault mode

The internal intelligent controller can continuously monitor and adjust the system status. If inverter finds any unexpected conditions such as system fault and inverter fault, the fault information will be displayed on the LCD. In fault mode the LED turns red.



Detailed fault information refers to chapter 10 Troubleshooting.

Information

8.4. Shutdown mode

Inverters automatically stop running during periods of little or no sunlight. In shutdown mode the inverters take no power from the grid and panel, and the LCD and LED turns off.



If the PV string DC voltage is too low (≤ 60 Vdc) or DC switch open, the inverter will also turn to shutdown Mode
Note: For Growatt 750-S, the PV low voltage is less than 50V.

Information

Maintenance and Cleaning 9

9.1. Checking heat dissipation

If the inverter regularly reduces its output power due to high temperature, please improve the heat dissipation condition. Maybe you need to clean the heat sink.

9.2. Checking the DC switch

Checking externally visible damage and discoloration of the DC switch. If there is any visible damage to the DC Disconnect, or visible discoloration, contact the installer.

Once a year, turn the rotary switch from the On position to the Off position 5 times in succession. This cleans the contacts of the rotary switch and prolongs the electrical endurance of the DC Disconnect

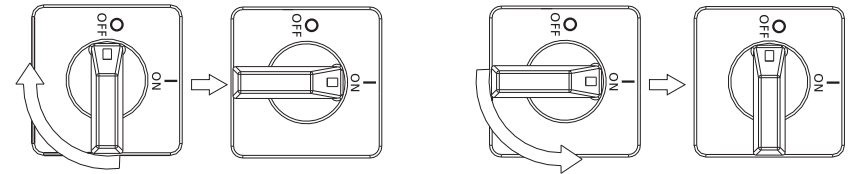

9.3. Cleaning the Inverter

If the inverter is dirty, clean the enclosure lid, the display, and the LEDs using only clean water and a cloth. Do not use any cleaning agents (e.g. solvents or abrasives).

10 Trouble Shooting

Sometimes, the PV inverter does not work normally, we recommend the following solutions for common troubleshooting. The following table can help the technician to understand the problem and take action.

10.1 Warnings(W)

Warnings(W) identify the current status of the Growatt inverter. Warnings do not relate to a fault. When a (W) with a number after it appears in the display, it indicates a Warning Code and is usually cleared through an orderly shutdown/reset or a self corrective action performed by the inverter. See the (W) codes in the following table.

Error message	Description	Suggestion
No AC Connection	No utility grid connected or utility grid power failure.	1.Check AC wiring. 2.Contact Growatt.
AC V Outrange	Utility grid voltage is out of permissible range.	1.Check grid voltage. 2.If the error message still exists despite the grid voltage being within the tolerable range, contact Growatt.
AC F Outrange	Utility grid frequency out of permissible range.	1.Check grid frequency. 2.If the error message is displayed despite the grid frequency being within the tolerable range, contact Growatt.
Over Temperature	Temperature outrange	1.check the inverter operation state 2.If the error message is displayed still, please contact Growatt.
PV Isolation Low	Insulation problem	1.Check if panel enclosure ground properly. 2.Check if inverter ground properly. 3.Check if the DC breaker gets wet. 4.If the error message is displayed despite the above checking passed, contact Growatt.
Output High DCI	Output current DC offset too high	1.Restart inverter. 2.If error message still exists, contact Growatt.
Residual I High	Leakage current too high	1.Restart inverter. 2.If error message still exists, contact Growatt.
PV Voltage High	The DC input voltage is exceeding the maximum tolerable value.	Disconnect the DC switch immediately.
Auto Test Failed	Auto test didn't passed.	Restart inverter



Information

If the suggestions do not work, please connect to the Growatt.

10.2 Errors(E)

Errors(E) codes identify a possible equipment failure, fault or incorrect inverter setting or configuration. Any and all attempts to correct or clear a fault must be performed by qualified personnel. Typically, the (E) code can be cleared once the cause or fault is removed. Some of the (E) codes, Error as indicated in the table below, may indicate a fatal error and require you to contact the supplier or the Growatt to replace a new one.

Error code	Description	Suggestion
Error: 101	Communication fault Slave processor can't receive data from Master processor.	1.Restart inverter 2.If error message still exists, contact Growatt.
Error: 102	Consistent fault. Data received by Master and Slave processor are different. The reason can be utility grid voltage or frequency change frequently.	1.Restart inverter. 2.If error message appears frequently or error message still exists after replacement, check utility grid. If you require help, contact Growatt. 3.If error message still exists, contact Growatt.
Error: 116	EEPROM fault	Contact Growatt.
Error: 117	Relay fault	Contact Growatt.
Error: 118	Init model fault	Contact Growatt.
Error: 119	GFCI Device Damage	Contact Growatt.
Error: 120	HCT fault	Contact Growatt.
Error: 121	Communication fault. Master processor can't receive data from Slave processor.	1.Restart the inverter 2.If error message still exists, contact Growatt..
Error: 122	Bus voltage fault	Contact Growatt.

11.1. Dismantling the Inverter

1. Disconnect the inverter as described in section 7.
2. Remove all connection cables from the inverter.



Danger of burn injuries due to hot enclosure parts!
Wait 20 minutes before disassembling until the housing has cooled down.

3. Screw off all projecting cable glands.
4. Lift the inverter off the bracket and unscrew the bracket screws.

11.2. Packing the Inverter

If possible, always pack the inverter in its original carton and secure it with tension belts. If it is no longer available, you can also use an equivalent carton. The box must be capable of being closed completely and made to support both the weight and the size of the inverter.

11.3. Storing the Inverter

Store the inverter in a dry place where ambient temperatures are always between -25°C and +60°C.

11.4. Disposing of the Inverter



Do not dispose of faulty inverters or accessories together with household waste. Please accordance with the disposal regulations for electronic waste which apply at the installation site at that time. Ensure that the old unit and, where applicable, any accessories are disposed of in a proper manner.

12.1. Specification

Model	Growatt 750-S	Growatt 1000-S	Growatt 1500-S	Growatt 2000-S	Growatt 2500-S	Growatt 3000-S
Input data(DC)						
Max. DC power	970W	1300W	1800W	2300W	2900W	3400W
Max. DC voltage	450V	450V	450V	450V	500V	550V
Start voltage	55V	80V	80V	80V	80V	80V
PV voltage range	50V-450V	70V-450V	70V-450V	70V-450V	70V-500V	70V-550V
MPP work voltage range/ nominal voltage	55V-450V /180V	70V-450V /180V	70V-450V /250V	70V-450V /360V	70V-500V /360V	70V-550V /360V
Full load dc voltage range	80V-400V	110V-400V	175V-400V	200V-400V	220V-450V	250V-500V
Max. input current	10A	10A	10A	11A	12A	13A
Max. input current per string	10A	10A	10A	11A	12A	13A
Number of independent MPP trackers / strings per MPP tracker	1 / 1	1 / 1	1 / 1	1 / 1	1 / 1	1 / 1
Output (AC)						
Rated AC output power	750W	1000W	1600W	2000W	2500W	3000W
Max. AC power	750W	1000W	1650W	2000W	2500W	3000W
Max. output current	3.4A	4.7A	7.8A	9.5A	11.9A	14.3A
AC nominal voltage; range	220V/230V/240V; 180Vac-280Vac					
AC grid frequency; range	50,60Hz;±5 Hz					
Power factor	0.8leading-0.8lagging					
THDI	<3%	<3%	<3%	<3%	<3%	<3%
AC connection	Single phase					

Efficiency						
Max. efficiency	97.2%	97.4%	97.4%	97.4%	97.6%	97.6%
Euro weighted efficiency	96%	96.5%	97%	97%	97.1%	97.3%
MPPT efficiency	99.5%	99.5%	99.5%	99.5%	99.5%	99.5%

Protection devices						
DC reverse polarity protection	yes	yes	yes	yes	yes	yes
DC switch rating for each MPPT	yes	yes	yes	yes	yes	yes
Output over current protection	yes	yes	yes	yes	yes	yes
Output over voltage protection-varistor	yes	yes	yes	yes	yes	yes
Ground fault monitoring	yes	yes	yes	yes	yes	yes
Grid monitoring	yes	yes	yes	yes	yes	yes
Integrated all - pole sensitive leakage current monitoring unit	yes	yes	yes	yes	yes	yes

General Data						
Dimensions (W / H / D) in mm	271/299/141	271/299/141	271/299/141	271/299/141	271/359/141	271/359/141
Weight	6.4KG	6.4KG	6.4KG	6.4KG	9.1KG	9.1KG
Operating temperature range	- 25°C ... +60°C (-13...+140°F) with derating above 45°C /113°F					
Noise emission (typical)	≤ 25 dB(A)					
Altitude	2000m(6560ft) without derating					
Self-Consumption night	< 0.5 W	< 0.5 W	< 0.5 W	< 0.5 W	< 0.5 W	< 0.5 W
Topology	transformerless					
Cooling concept	Natural	Natural	Natural	Natural	Natural	Natural
Environmental Protection Rating	Ip65	Ip65	Ip65	Ip65	Ip65	Ip65
Relative humidity	100%	100%	100%	100%	100%	100%

Features						
DC connection	H4	H4	H4	H4	H4	H4
AC connection	connector	connector	connector	connector	connector	connector
Display	LCD	LCD	LCD	LCD	LCD	LCD
Interfaces: RS232/Wifi	yes/opt	yes/opt	yes/opt	yes/opt	yes/opt	yes/opt
Warranty: 5 years / 10 years	yes /opt	yes /opt	yes /opt	yes /opt	yes /opt	yes /opt
Certificates and approvals	CE, VDE 0126-1-1, VDE-AR-N-4105, IEC 62109, G83, AS4777, NBT32004-2013, EN50438, CEI 0-21, INMETRO					

12.2. DC connector info

DC connection	H4
---------------	----

12.3. Torque

Enclosure lid screws	7kg.cm
Shell and RS232 screws	7kg.cm
AC terminal	6kg.cm
Additional ground screws	20kg.cm

13 PV System Installation

Compliance Certificates 14

13.1. Single inverter

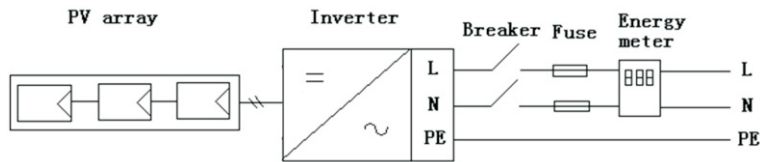

13.2. Multi inverters

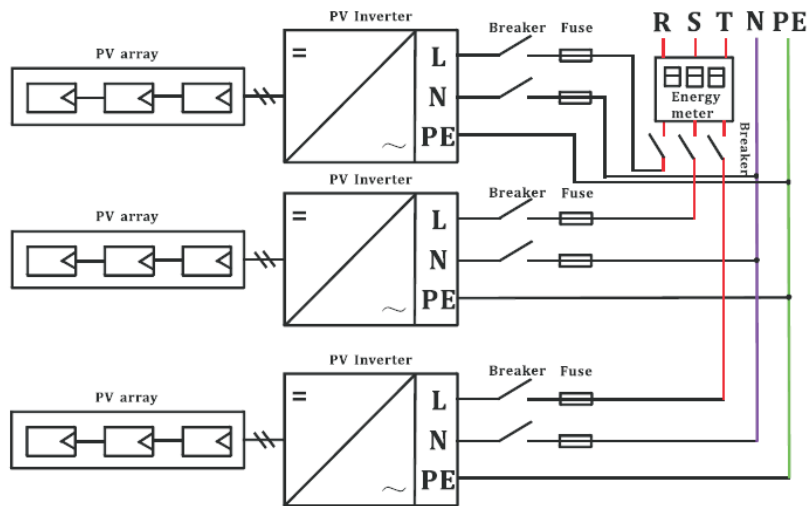

14.1. List

Growatt750-S-3000-S

Certificates	CE, VDE 0126-1-1, VDE-AR-N-4105, IEC 62109, AS4777, NBT32004-2013, EN50438, CEI 0-21, INMETRO
Declaration	G83

14.2. Download address

www.ginverter.com/Download.aspx

15 Contact

If you have technical problems about our products, contact the GROWATT Serviceline. We need the following information in order to provide you with the necessary assistance:

- > Inverter type
- > Serial number of the inverter
- > Event number or display message of the inverter
- > Type and number of PV modules connected
- > Optional equipment